



2024

SMART LAMP
BROCHURE

About us

NBHanyuan Lighting Co., Ltd is one of the leading manufacturers of Outdoor lighting, located in Ningbo, a beautiful port City in the east of China.

Dare to be different, Hanyuan is always known for its innovation, Hanyuan's outstanding R&D team designed hundreds of new products and got hundreds of design patents in both Europe and China.

With 18 year manufacture experience, Hanyuan has formed a comprehensive product line and earned a good reputation in the global market. Hanyuan is also capable of new tooling and testing new products independently.

The company conducts ISO9001, BSCI, and Sedex, and is awarded as a National High-tech Enterprise by the Chinese government. All products of Hanyuan are TUV-approved and GS/CE/RCM certificated. Hanyuan's exclusive painting technique allow products easily pass 300 hours salt spray test, with excellent performance in anti-corrosion.

With a strong R&D team, efficient management system, powerful production capacity, and strict quality control, Hanyuan will continuously supply quality products that exceed your expectations...

Managing Director:

Gang Mao



Scan and watch video on  YouTube

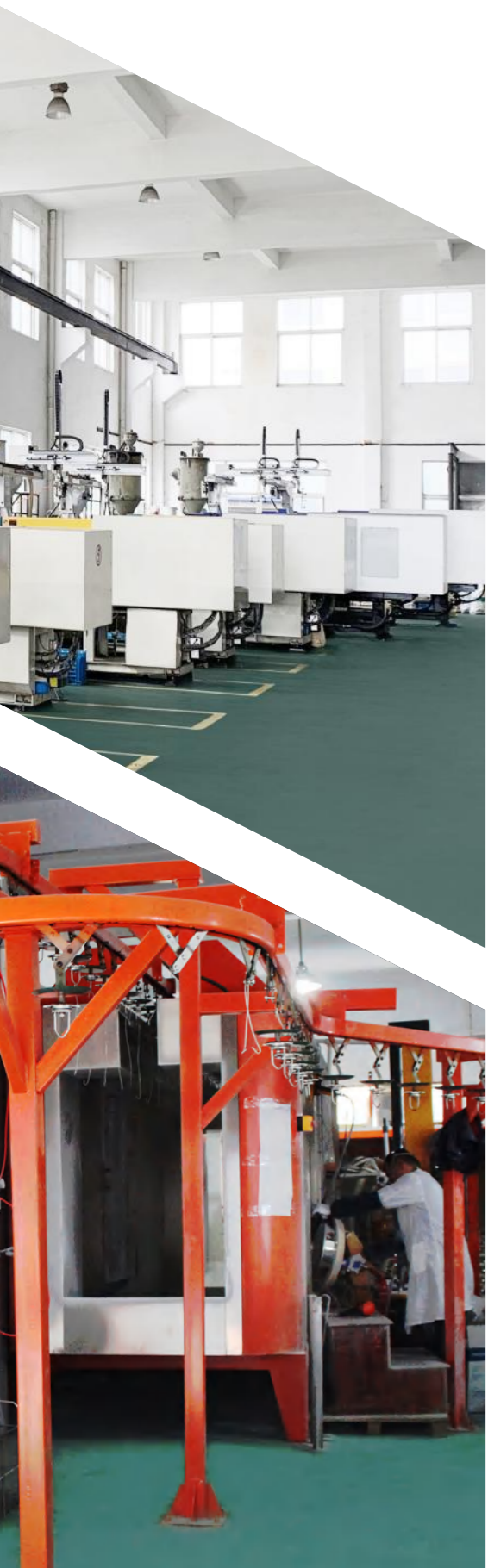

Smart light

Connection management

Support automatic detection of new equipment one button to complete the network;

Support manual control and voice control (including third-party voice control across Amazon Echo and Google Home)

Support Wi-Fi, Bluetooth, and other communication protocols of intelligent product connection and control.

All-in-one App

One-click execution and automation are supported to link devices at home and experience real smart life services.

Download the App

Scan the QR-code or search tuya smart in the store to download the free app, which supports registration free function and can be used without registration; Support email, and mobile phone login registration; Support mainstream three-party login, including Google, Apple, etc.



Scan and watch video on YouTube



Warm White

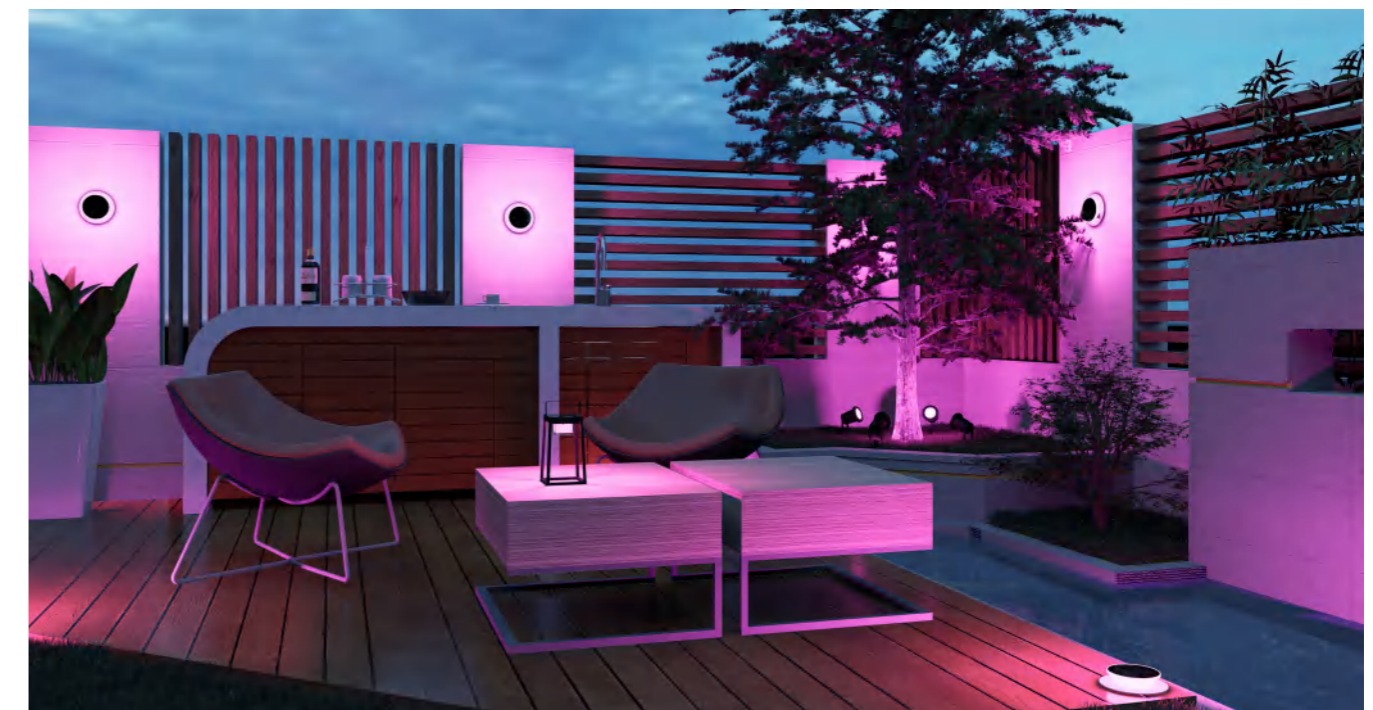

RGB Multicolor



16 million colors follow the heart changes, appear fuller



The lights dance with music, and the lights move with the rhythm of the lights

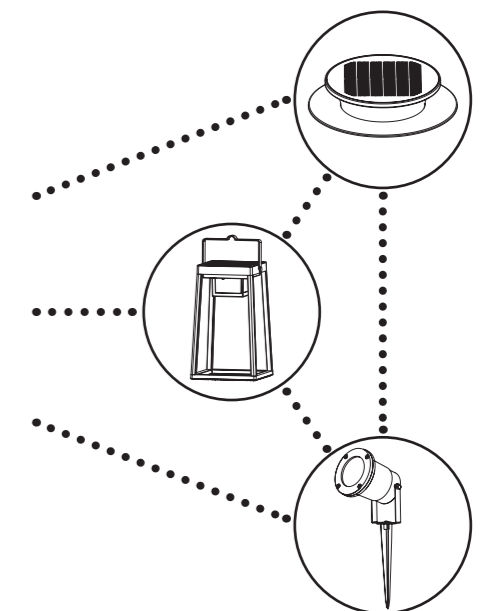

Smart light

We are excited to present our NBHanyuan Smart Outdoor collection. Enjoy the endless possibilities with a variation of stylish lighting solutions for your garden.

Classic, modern, industrial, Tuya has you covered! No loose bulbs in outdoor fixtures, but a fully integrated smart system that is based on Bluetooth Mesh.

Regardless the size of your garden or the number of items you place, these products are all interconnected and manageable from the same Tuya app used for your existing NBHanyuan products.

Light up your garden with warm white light for long summer evenings or choose from 1600+ color options to match your mood.

Easily set timers, automations and personal preferences with the new NBHanyuan Outdoor collection.

Creating a smart garden has never been easier!



CCT
adjustable whites

Dimming

4 shades of light

Activity light

Night Reading Relaxing



CCT+RGB
whites & colors

Dimming

Warm white to Cold white

16million colors

Activity lights

Night Reading Relaxing Party

Fire Ocean Forest Romance

EXPLORE



Lighting Technology
220 - 240V Luminaires with integrated LED

Body color
Black

Material
Aluminum die casting + PC Shade

IP
IP44

Certification
CE  **RoHS**
ISO9001-2015 ISO14000  **BSCI** Sedex

CCT: 3000 - 6500K dimmable



Scan and watch video on  YouTube

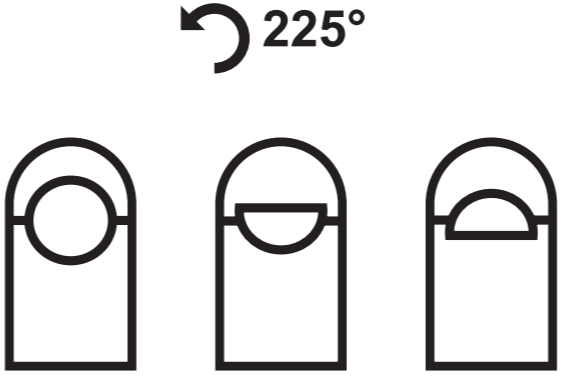
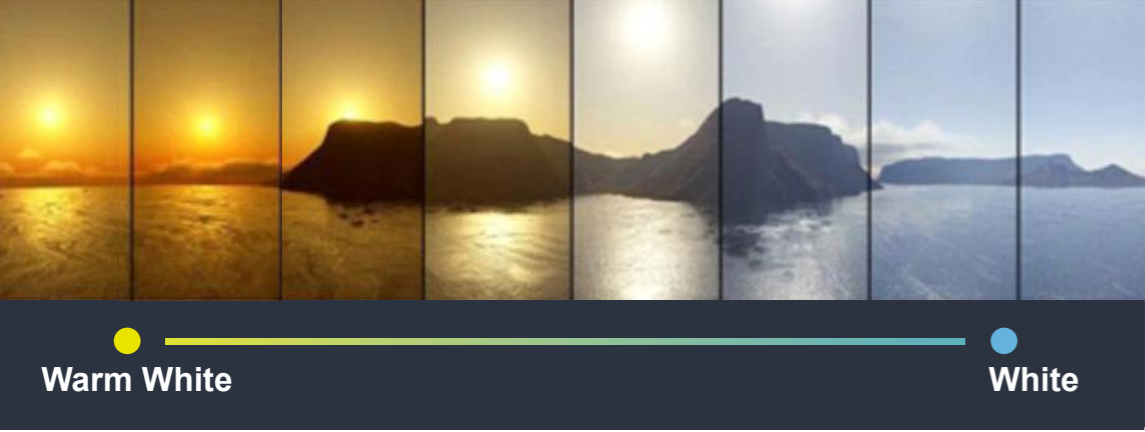

HY031PSH 0,7mB-T
17 x 10 x 70cm
6,7W 420lm

EXPLORE

Lighting Technology

220 - 240V Luminaires with integrated LED

Body color

Black

Material

Aluminum die casting + PC Shade

IP

IP44

Certification

CE  RoHS
ISO9001-2015 ISO14000  BSCI Sedex

CCT: 3000 - 6500K dimmable



Scan and watch vedio on  YouTube

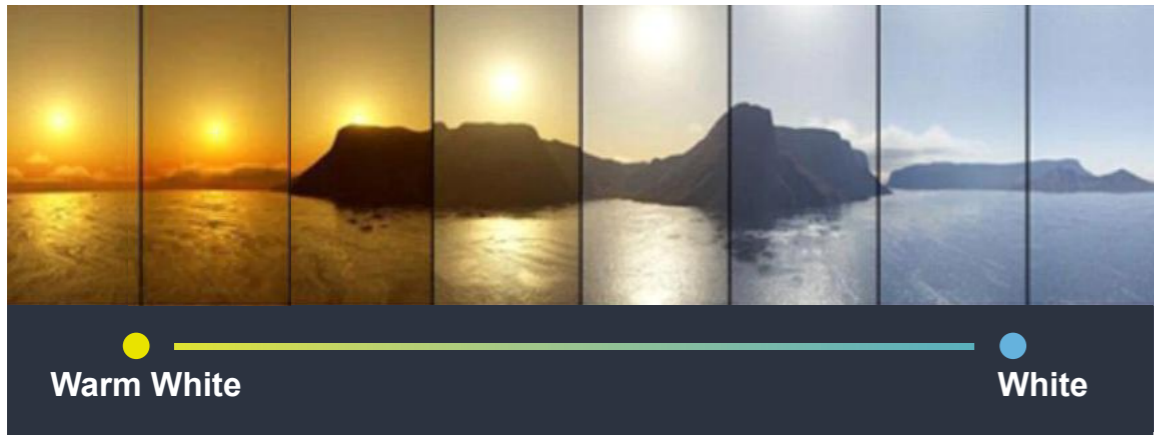

 225°

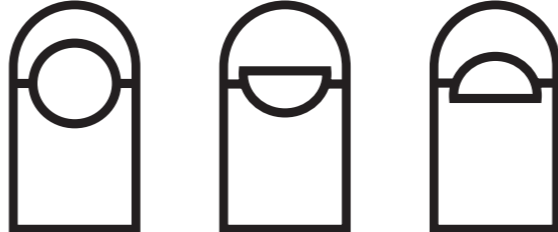

HY031AUPB-T

16 x 6,5 x 18,5cm
6,7W 420lm

ALPS



Lighting Technology

Solar Panel: monocrystalline 1.8W
 Battery: 1 x 18650 Li-ion 3.7V 2200 mAh

Body color

Black

Material

Alumium die casting+ PC shade

Smart Lighting

RGB+3000K
 with integrated LED

IP

IP44

USB Type C cable allows also to charge
 via an electrical network

Certification

CE RoHS
 ISO9001-2015 ISO14000 BSCI Sedex

ALPS

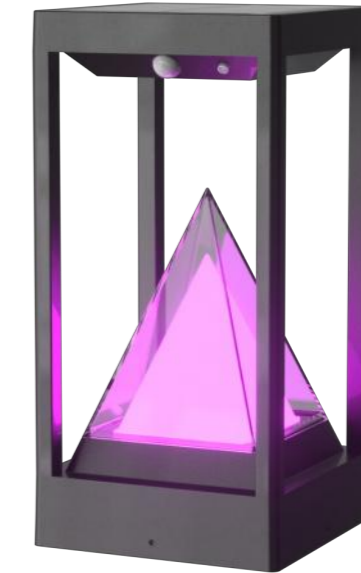

HY51PST 0.31mB-T

15,2 × 15,2 × 31cm



Scan and watch vedio on YouTube

Lighting Technology

Solar Panel: monocrystalline 1.8W
 Battery: 1 x 18650 Li-ion 3.7V 2200 mAh

Body color

Black

Material

Alumium die casting+ PC shade

Smart Lighting

RGB+3000K
 with integrated LED

IP

IP44

USB Type C cable allows also to charge
 via an electrical network

Certification

CE RoHS
 ISO9001-2015 ISO14000 BSCI Sedex

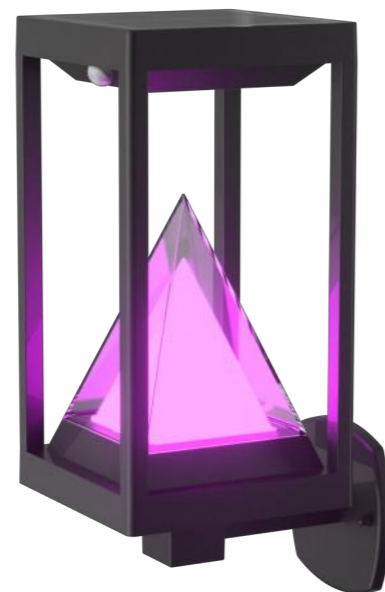

HY51WSRB-T

19,5 x 15,2 x 36,5cm



ALPS



Lighting Technology

Solar Panel: monocrystalline 1.8W
 Battery: 1 x 18650 Li-ion 3.7V 2200 mAh

Body color

Black

Material

Alumium die casting+ PC shade

Smart Lighting with motion sensor

RGB+3000K
 with integrated LED

IP

IP44

USB Type C cable allows also to charge
 via an electrical network

Certification

CE  RoHS
 ISO9001-2015 ISO14000  BSCI No. 022287 Sedex



HY51PSR 0.5mB-T

15,2 x 15,2 x 49cm

HY51PSR 0.7mB-T

15,2 x 15,2 x 69cm

ALPS



Lighting Technology

Solar Panel: monocrystalline 1.8W
 Battery: 1 x 18650 Li-ion 3.7V 2200 mAh

Body color

Black

Material

Alumium die casting+ PC shade

Smart Lighting with motion sensor



RGB+3000K
 with integrated LED

IP

IP44

USB Type C cable allows also to charge
 via an electrical network

Certification

CE  RoHS
 ISO9001-2015 ISO14000  BSCI No. p22287 Sedex



HY51PSRA 0,7mB-T

15,2 x 15,2 x 70,5cm

LANTERN

Lighting Technology

Solar Panel: monocrystalline 1.8W
 Battery: 1 x 18650 Li-ion 3.7V 2200 mAh

Body color

Black

Material

Alumium die casting+ PC shade

Smart Lighting

RGB+3000K
 with integrated LED

IP

IP44

USB Type C cable allows also to charge
 via an electrical network

Certification

CE  RoHS
 ISO9001-2015 ISO14000  BSCI Sedex

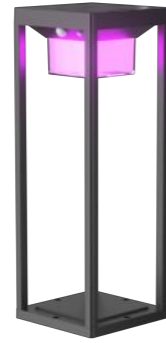

HY54PST 0,44mB-T

15,2 x 15,2 x 43,5cm



HY54PSR 0,5mB-T

15,2 x 15,2 x 49cm

HY54PSR 0,7mB-T

15,2 x 15,2 x 69cm

LANTERN



Lighting Technology

Solar Panel: monocrystalline 1.8W
 Battery: 1 x 18650 Li-ion 3.7V 2200 mAh

Body color

Black

Material

Alumium die casting+ PC shade

Smart Lighting



RGB+3000K
 with integrated LED

IP

IP44

USB Type C cable allows also to charge
 via an electrical network

Certification

CE  RoHS
 ISO9001-2015 ISO14000  BSCI Sedex



HY54WSRB-T

19,5 x 15,2 x 35,6cm

LANTERN



Lighting Technology

Solar Panel: monocrystalline 1.8W
Battery: 1 x 18650 Li-ion 3.7V 2200 mAh

Body color

Black

Material

Alumium die casting+ PC shade

Smart Lighting

RGB+3000K
with integrated LED

IP

IP44

USB Type C cable allows also to charge
via an electrical network

Certification

CE  RoHS
ISO9001-2015 ISO14000  BSCI No. 022287 Sedex



HY54TSRB-T

18 x 18 x 30cm



Scan and watch vedio on  YouTube



Scan and watch vedio on  YouTube

LUFFY



Lighting Technology

Solar Panel: monocrystalline 1.8W
Battery: 1 x 18650 Li-ion 3.7V 2200 mAh

Body color

Black

Material

Alumium die casting+ PC shade

Smart Lighting

RGB+3000K
with integrated LED

IP

IP44

USB Type C cable allows also to charge
via an electrical network

Certification

CE  RoHS
ISO9001-2015 ISO14000  BSCI No. p22287 Sedex



HY52TSRB-T

ø20 x 26cm



Scan and watch vedio on  YouTube

ALPS



Lighting Technology

Solar Panel: monocrystalline 1.8W
 Battery: 1 x 18650 Li-ion 3.7V 2200 mAh

Body color

Black

Material

Alumium die casting+ PC shade

Smart Lighting

RGB+3000K
 with integrated LED

IP

IP44

USB Type C cable allows also to charge
 via an electrical network

Certification

CE RoHS
 ISO9001-2015 ISO14000 BSCI No. 022287 Sedex

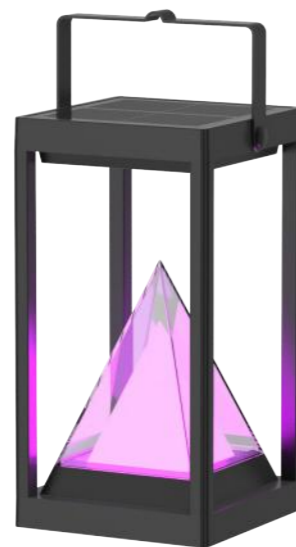

HY51TSRB-T

15,2 x 15,2 x 29cm

FAIRY



Lighting Technology

Solar Panel: monocrystalline 1.8W
 Battery: 1 x 18650 Li-ion 3.7V 2200 mAh

Body color

Black

Material

Alumium die casting+ PC shade

Smart Lighting

RGB+3000K
 with integrated LED

IP

IP44

USB Type C cable allows also to charge
 via an electrical network

Certification

CE RoHS
 ISO9001-2015 ISO14000 BSCI No. 022287 Sedex



HY53TSRB-T

18 x 18 x 30cm



Scan and watch video on YouTube



HY54TSRAB

15,2 x 15,2 x 43,5cm

LUMINA+

Lighting Technology

Solar Panel: monocrystalline 6W

Battery: 3 x 18650 Li-Ion battery 3.7V 2200 mAh

Body color

Black

Material

ABS+PC shade

Smart Lighting

RGB+3000K

with integrated LED

IP

IP65

Certification

CE  RoHS

ISO9001-2015 ISO14000  BSCI Sedex



HY26WSR+804B-T

Panel Size: ø24,5 x 20,5 x 31,6cm

Lamp Size: ø9,2 x 9,6cm



LUMINA+



Lighting Technology

Solar Panel: monocrystalline 6W

Battery: 3 x 18650 Li-Ion battery 3.7V 2200 mAh

Body color

Black

Material

Stainless Steel 316, Glass shade

Smart Lighting

RGB+3000K

with integrated LED

IP

IP65

Certification

CE  RoHS

ISO9001-2015 ISO14000  BSCI Sedex



HY26WSR+801B

Panel Size: ø24,5 x 20,5 x 48cm

Lamp Size: ø10 x 11,5cm



HY26WSR+801-T

Panel Size: ø24,5 x 20,5 x 31,6cm

Lamp Size: ø10 x 7,5cm

MOON



HY62WLRW-T

ø16 x 4,1cm

Lighting Technology

Solar Panel: monocrystalline 1W
Battery: 1 x 18650 Li-Ion battery 3.7V 2200 mAh

Body color

White

Material

PC

Smart Lighting

RGB+3000K
with integrated LED

IP

IP65

Certification

CE RoHS
ISO9001-2015 ISO14000  Sedex

RUBY

Lighting Technology

Solar Panel: monocrystalline 2W
Battery: 1 x 18650 Li-Ion battery 3.7V 2200 mAh

Body color

Black

Material

Stainless Steel , ABS+PC shade

Smart Lighting

RGB+3000K
with integrated LED
allows to install 2nd battery for double working time

IP

IP44

Certification

CE RoHS
ISO9001-2015 ISO14000  Sedex

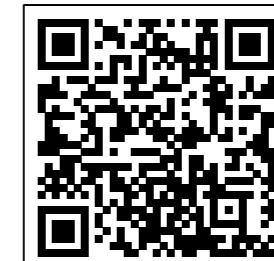

Scan and watch video on 

HY25WSR+02-T

Panel Size: 15 x 15 x 20cm
Spike Size: ø25 x 14cm
Lamp Size: ø4,8 x 45,5cm (include spike)



RITA



Lighting Technology

Solar Panel: monocrystalline

Battery: 1 x 18650 Li-Ion battery 3.7V 2200 mAh

Body color

White/ Grey/ Black

Material

Plastic, PC shade

Smart Lighting

RGB+3000K
with integrated LED

IP

IP54

Speical Function:

- 1) allows to charge the lamp via an electrical network
- 2) allows to install 2nd battery for double working time

Certification

CE RoHS

ISO9001-2015 ISO14000  Sedex



HY35TSRW-T

14 x 14 x 23cm



HY35TSRG-T

14 x 14 x 23cm



Scan and watch vedio on  YouTube

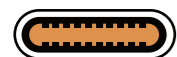

Type C charging port

ROSA

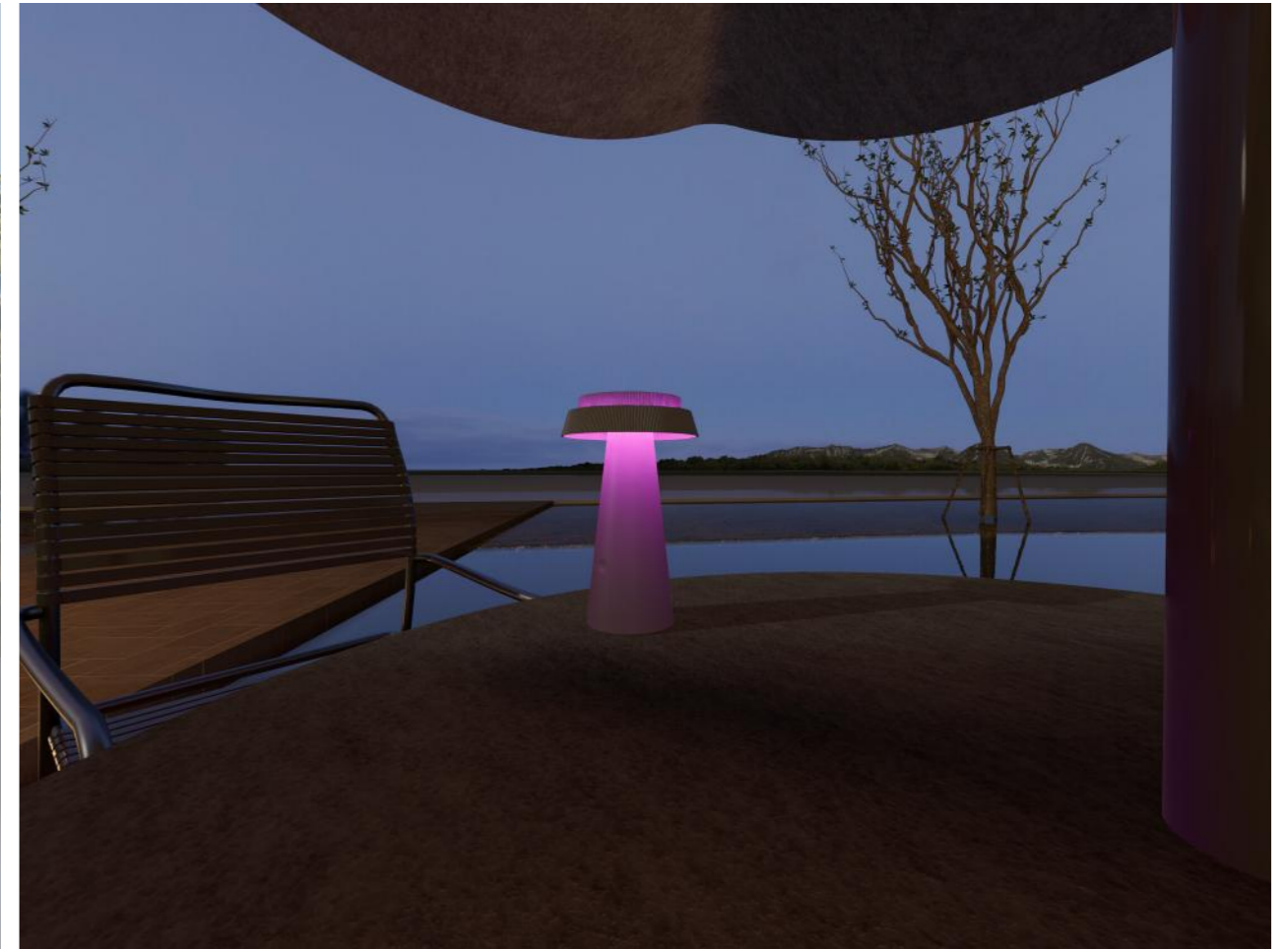

HY36TSRW-T

14 x 14 x 23cm



HY36TSRG-T

14 x 14 x 23cm

Lighting Technology

Solar Panel: monocrystalline

Battery: 1 x 18650 Li-Ion battery 3.7V 2200 mAh

Body color

White/ Grey/ Black

Material

Plastic, PC shade

Smart Lighting

RGB+3000K
with integrated LED

IP

IP54

Special Function:

- 1) allows to charge the lamp via an electrical network
- 2) allows to install 2nd battery for double working time

Certification

CE RoHS

ISO9001-2015 ISO14000  Sedex

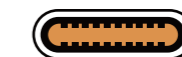

Type C charging port



NBHANYUAN
Lighting

Ningbo Hanyuan Lighting Co.,Ltd.

657 Xiufeng Rd.,Gaoqiao Industry Zone, Haishu District, Ningbo 315174, Zhejiang, China
Tel: 0086.574.88089627 | Fax: 0086.574.88055881 | E-mail: sales@nblighting.com

